

Royal Entomological Society



HANDBOOKS FOR THE IDENTIFICATION OF BRITISH INSECTS

To purchase current handbooks and to download
out-of-print parts visit:

<http://www.royensoc.co.uk/publications/index.htm>



This work is licensed under a [Creative Commons Attribution-NonCommercial-ShareAlike 2.0 UK: England & Wales License](https://creativecommons.org/licenses/by-nc-sa/2.0/).

Copyright © Royal Entomological Society 2013

Handbooks for the Identification of British Insects
Vol. 6, Part 5

CUCKOO-WASPS
HYMENOPTERA, CHRYSIDIDAE

D. Morgan



ROYAL ENTOMOLOGICAL SOCIETY OF LONDON

Handbooks for the
Identification of British Insects

Vol. 6, Part 5

Editors: M.G. Fitton & P.C. Barnard

CUCKOO-WASPS
HYMENOPTERA, CHRYSIDIDAE

By

D. Morgan
Department of Entomology
British Museum (Natural History)
London SW7 5BD

1984
ROYAL ENTOMOLOGICAL SOCIETY OF LONDON

The aim of the *Handbooks* is to provide illustrated identification keys to the insects of Britain, together with concise morphological, biological and distributional information. The series also includes a *Check List of British Insects*.

Each handbook should serve both as an introduction to a particular group of insects and as an identification manual.

Details of handbooks currently available, and an order form, can be obtained from the Royal Entomological Society, 41 Queen's Gate, London SW7 5HU.

World List abbreviation: *Handbk Ident. Br. Insects*.

© Royal Entomological Society of London, 1984.

First published 1984 by the Royal Entomological Society of London, 41 Queen's Gate, London SW7 5HU.

Printed by Dramrite Printers Limited, Southwark, London SE1.

Contents

	<i>Page</i>
Introduction	3
Classification	4
Characters and character variation	5
Biology	6
Collecting and preservation	7
Check list of Chrysididae recorded from Britain and the Channel Islands	7
Nomenclatural notes and lectotype designations	8
Morphological terminology	10
Notes on the keys	11
Key to world subfamilies	11
Key to genera	12
Subfamily Cleptinae	13
Genus <i>Cleptes</i>	13
Subfamily Elampinae	14
Genus <i>Elampus</i>	14
Genus <i>Omalus</i>	15
Genus <i>Hedychrum</i>	16
Genus <i>Hedychridium</i>	16
Genus <i>Holopyga</i>	17
Subfamily Chrysidinae	18
Genus <i>Spinolia</i>	18
Genus <i>Trichrysis</i>	19
Genus <i>Chrysura</i>	19
Genus <i>Chrysogona</i>	20
Genus <i>Chrysis</i>	20
Acknowledgements	23
References	24
Figures	27
Index	37

Introduction

Among the British aculeate Hymenoptera, the Chrysididae constitute a spectacularly coloured but little known group of parasitic wasps, commonly referred to as cuckoo-wasps, ruby-tailed-wasps or jewel-wasps. They have a thick and usually heavily sculptured cuticle, richly coloured in brilliant metallic reds, greens, blues and golds. The adults feed at flowers and extra-floral nectaries of plants; the larvae of the British species develop in the cells of solitary bees and wasps, and in the cocoons of sawflies (Hymenoptera). Chrysidid wasps favour bright sunlight and are on the wing from late April to early September, when they can be observed investigating holes in various substrates, the possible nesting sites of their hosts.

In Great Britain, Ireland and the Channel Islands there are 11 genera and 33 species, the greatest diversity of species being found in southern England. It has been estimated that the number of described species in the Chrysididae, with allowance for probable synonymy, is about 3,000 (Bohart & Kimsey, 1982), with the Palaearctic region having by far the greatest number. Approximately thirty genera are currently recognised in the world.

Classification

Recent classifications have allied the Chrysididae with the bethyloid group of families, an articulation rather than a constriction in the second valvifer of the sting is a strong unifying character of the group. Perkins (1976) in an earlier handbook dealing with the Bethyloidea, excluded the Chrysididae. Since then Day (1977) has pointed out that the name Chrysididae Latreille, 1802 has priority over Bethyloidea Haliday, 1839; Cleptoidea Latreille, 1802 being rejected under the first reviser principle. Chrysididae in Britain are distinguished by both sexes having thirteen antennal segments, a reduction in forewing venation, the hindwing in lacking cells closed by veins and in lacking a jugal lobe (= anal lobe of Richards, 1977) but with a plical lobe (= vannal lobe of Richards, 1977) indicated by an incision of the wing margin, and the pronotum being not closely coadapted to the mesepisternum. In the Chrysididae, the central part of the metanotum is often fused with the propodeum, and the number of visible gastral segments is reduced.

The present survey mainly follows the classification used in Linsenmaier's (1959) revision of the Chrysididae. At the time this made notable advances from the artificial system then in use, which had evolved from the format initially proposed by Lichtenstein in 1876, based on the form of, and number of teeth on the apical margin of the third gastral tergite. The form of the apical margin of the third gastral tergite is still seen as a useful character, but not one on which an entire classification can be based.

The family Chrysididae is divided into seven subfamilies; Amiseginae, Parnopinae, Allocoeliinae, Loboscelidiinae, Cleptinae, Elampinae and Chrysidinae, of which only the last three are found in Britain.

The first British work was produced by Harris (1776-1780), who described seven chrysidid species; five were proposed as new, but only one (*Chrysis radians* Harris) is recognised. Shuckard published a major work on the British Chrysididae in 1836, in which 24 species were listed, though some names represented the different sexes of the same species. At the turn of the century Morice (e.g. 1896-1902) contributed numerous papers on the British Chrysididae including new species, distribution records, biologies, and keys for identification. The only significant work after this was Spooner's (1954) key to the British species of *Omalus*.

In contrast to the shortage of British work, there are numerous major Palaearctic studies on the Chrysididae, as follows: Atanassov, 1940 (Bulgaria); Balthasar, 1951 (Palestine), 1953 (Czechoslovakia); Benno, 1950 (Holland); Berland & Bernard, 1938 (France); du Buysson, 1891-96 (Europe & Algeria); Haupt, 1956 (Central Europe); Linsenmaier, 1959, 1968 (World, mainly Palaearctic); Mocsáry, 1889 (World); Móczár, 1964, 1967 (Hungary); Noskiewicz & Pulawski, 1958 (Poland); Semenov-Tyan-Shanskii, 1967 (Russia); Trautmann, 1927 (Europe). Although this list appears a considerable body of work, few authors have included original morphological studies or comprehensive keys, and surprisingly little attention has been paid to the study of type-material. The result has been a fairly conservative approach to Chrysididae taxonomy.

Characters and character variation

Among the subfamilies the gaster shows marked specialisation. In the Chrysidinae and Elampinae visible gastral segments are reduced to three, whereas Amiseginae and Cleptinae females have four visible segments, the males have five. In the Parnopinae there are three visible segments in the female and four visible in the male. The remaining gastral segments, concealed in all chrysidid females, are modified to form a thin telescopic tube which functions as an ovipositor (fig. 87), a secondary development not seen in other aculeate Hymenoptera. Despite the development of this specialised egg placement system, the Chrysididae have still retained a sting apparatus. Its effectiveness is certainly reduced as the telescopic tube bends in *Chrysis ignita* when the sting unsuccessfully tries to penetrate human skin (personal observation).

Except for the Amiseginae, Loboscelidiinae and Cleptinae, chrysidid wasps have the ventral surface of the gaster concave, enabling it to be turned under the thorax and allowing the insect to roll up in a defensive position if threatened or disturbed (fig. 86). Normally, if a host returns to its nest and finds a chrysidid, it will chase it away, but should the chrysidid adopt its rolled defensive position, the host carries the chrysidid out of the nest and drops it (Isely, 1913).

Apart from the numbers of gastral segments discussed above, the Chrysididae show little sexual dimorphism, except in the winged males and wingless females of most Amiseginae, and in the Loboscelidiinae where females have relatively short, thick antennae, and males have long thin antennae. Males and females have the same number of antennal segments, thirteen, unlike the majority of aculeates which have twelve in the female and thirteen in the male. Another distinction from other aculeates is the first instar larva which is of the planidium type (fig. 90, drawn from photograph, Krombein, 1967) that actively seeks out its prey (this type of larva is also found in the Sapygidae). The larva bears long setae and the rear of the abdomen has forked fleshy pseudopods; both adaptations are to assist locomotion. It also possesses sharp piercing mandibles and long antennae. The mature (post-defaecating) larva of *Chrysis ignita* has been described by Yamane (1976).

Early work on separating the British species was largely based on colour, now known to be a variable character. Intraspecific variability, which is partly host-induced, also created numerous misconceptions concerning the limits of species. Only recently have more consistent characters been sought, allowing more accurate separation of the species. It is hoped the keys presented below reflect this search for good characters, many of which are utilised for the first time. Many advances in genus-level taxonomy have been made in recent years. The taxonomy of the largest genus, *Chrysis*, is still very confused, but introductory work carried out on the concealed gastral tergites by Lorencowa (1962) and Noskiewicz & Lorencowa (1963) appears to give a good indication of how species-group relationships may eventually be worked out in this large genus.

In general chrysidid wasps show structural conservatism, as do many other parasitic groups, but at the same time, they can show considerable intraspecific variation, which may be a result of host influence. The size of the adult chrysidid is certainly influenced by the host size. Whether the host larva or its food store is consumed, the size of the available food mass directly influences the size of the adult chrysidid; smaller hosts result in smaller parasites. The size of the adult chrysidid directly affects the diameter and distribution of the body punctures. In extremely small individuals the punctures are of a minimum size but are relatively large and dense when compared to the overall size of the body. This is most obvious on the gaster, and has been observed in chalcid wasps and studied in breeding experiments with Braconidae. *Chrysis mediata* clearly shows such host-induced variation. In Britain this species parasitises *Odynerus spinipes* (Eumenidae)

account taken of the previous inadequacy of available keys for species identification. Many host records are thus incomplete, usually inferred rather than proven, and perpetuating inaccuracies and misconceptions. In many cases too few records are available to allow conclusions to be drawn concerning habitat preference, or distribution of species. In this paper only confirmed biological data have been accepted. Few life cycles have been documented. If the host is known, seldom are biological details recorded. It is hoped that study of the biology of this poorly observed group will be stimulated by the production of these identification keys.

Further biological information is recorded at relevant positions throughout the text.

Collecting and preservation

Chrysidid wasps can be collected by hand-net while they are feeding at flowers, or extra-floral nectaries of plants. They can also be netted while on the wing, their metallic colours giving a distinctive appearance, particularly on sunny days. Their habit of rolling up when disturbed can make them evasive, either dropping to the ground, or to the bottom of the hand-net. It is, however, very difficult to net them while they are investigating the possible nesting sites of their hosts, dashing in and out of holes and cavities in various substrates. An effective method is to place a glass tube over a hole they have entered and wait for them to emerge, hopefully out of the same hole. Both collecting and biological study can be carried out by the use of trap-nests. Pieces of wood are bored with suitably sized holes to attract host species to build cells in them. The wood is also split to enable cells to be inspected if a nest is built (fig. 95). Hollow canes can also be used (fig. 94). A massive work on trap-nesting in North America has been written by K. V. Krombein (1967). This is a major reference work on the subject, and is vital reading for anyone intending a trap-nesting project. No comparable British work exists, but there is a study by H. V. Danks (1971) on stem-nesting aculeate Hymenoptera. While this includes the use of trap-nests, it concentrates on nests found in dead stems of *Rubus* species (bramble). These can be collected in winter, and stored in a suitable container until the adult wasps emerge, usually the following summer.

Most chrysidid wasps can be mounted by direct pinning with continental length stainless steel pins. Individuals too small to take a pin can be fixed with a minimum quantity of glue to the point of a small card triangle, which is itself pinned. This method allows a maximum of surface area for examination, and prevents damage that can result from trying to pin very small specimens directly. Care should be taken to ensure that specimens are adequately relaxed to enable the gaster to be pulled out from the underside of the thorax, its usual position in a majority of dead chrysidid wasps (fig. 86).

Check list of Chrysididae recorded from Britain and the Channel Islands

The following list corrects and updates that in Kloet & Hincks (1978), with a total of 33 species in 11 genera. Channel Island species not found in the British Isles are indicated by an asterisk (*).

CHRYSIDOIDEA

CHRYSIDIDAE

CLEPTINAE

CLEPTES Latreille, 1802

nitidulus (Fabricius, 1793)

semiauratus (Linnaeus, 1761)

pallipes Lepeletier, 1805

ELAMPINAE

ELAMPUS Spinola, 1806

NOTOZUS Förster, 1853

panzeri (Fabricius, 1804)

scutellaris (Panzer, 1798) preocc.

constrictus misident.

OMALUS Panzer, 1801
aeneus (Fabricius, 1787)
auratus (Linnaeus, 1758)
puncticollis (Mocsáry, 1887)
truncatus (Dahlbom, 1831)
violaceus (Scopoli, 1763)

HEDYCHRIDIUM Abeille de Perrin, 1878
ardens (Latreille in Coquebert, 1801)
coriaceum (Dahlbom, 1854)
cupreum (Dahlbom, 1845) **sp. rev.**
integrum (Dahlbom, 1854) **syn. nov.**
roseum (Rossi, 1790)

HEDYCHRUM Latreille, 1802
niemelai Linsenmaier, 1959, **stat. nov.**
nobile misident.
rutilans Dahlbom, 1854
intermedium misident.

HOLOPYGA Dahlbom, 1845
ovata Dahlbom, 1854 *
amoenua misident.

CHRYSIDINAE
CHRYSIDIS Linnaeus, 1761
angustula Schenck, 1856
brevidens Tournier, 1879
bicolor Lapeletier, 1805 *
fulgida Linnaeus, 1761

helleni Linsenmaier, 1959
chrysoprasina Hellén, 1919 preocc.
succincta misident.
ignita (Linnaeus, 1758)
impressa Schenck, 1856
longula Abeille de Perrin, 1879
mediata Linsenmaier, 1959
pseudobrevitarsis Linsenmaier, 1951
ruddii Shuckard, 1837
rutiliventris Abeille de Perrin, 1879
vanlithi Linsenmaier, 1959, **syn. nov.**
schencki Linsenmaier, 1968
schenckiana Linsenmaier, 1959 preocc.
viridula Linnaeus, 1761
ornatus Smith, 1851

CHRYSOGONA Förster, 1863
gracillima (Förster, 1853)

CHRYSTURA Dahlbom, 1845
hirsuta Gerstäcker, 1869
osmia Thomson, 1870
radians (Harris, 1781)
pustulosa Abeille de Perrin, 1878, **syn. nov.**

TRICHYSIS Lichtenstein, 1876
cyanea (Linnaeus, 1758)

SPINOLIA Dahlbom, 1854
PSEUDOSPINOLIA Linsenmaier, 1951
neglecta (Shuckard, 1836)

Nomenclatural notes and lectotype designations

Hedychridium integrum Dahlbom, 1854 is here placed in synonymy with *H. cupreum*. Dahlbom wrongly proposed *integrum* as a replacement name for *cupreum*, considering *cupreum* to be a homonym of *cupratum*, a species described by Klug. However, under the International Code of Zoological Nomenclature they are not considered homonyms, and *cupreum* is the valid name for the species. Kloet & Hincks (1978) incorrectly listed the species here recognised as *H. cupreum* as *H. integrum* Dahlbom, 1831. The latter is in fact *Chrysis integra* Fabricius sensu Dahlbom, 1831.

Hedychrum niemelai was described by Linsenmaier as a subspecies of *H. aureicolle*, but sufficient differences exist to regard it as a distinct species.

Hedychrum intermedium Dahlbom, 1845 was found to belong to the genus *Holopyga* (**comb. nov.**) on studying the type-specimen. This interpretation agrees with the label on the specimen "*Hol. intermedia* Gall. Dufour", and there is no doubt this is the intended type of "*Hed. intermedium* nob ♂ Gallia rar. Dufour" from the description (Dahlbom was citing Dufour as collector). The above species is not a synonym of *rutilans*.

Chrysis rutiliventris in Britain was previously referred to the subspecies *vanlithi*, here synonymised in support of the views of Valkeila (1971).

Harris proposed five new species in his work on the British chrysidids in 1776-1780. Although none of his type-material remains, an accurate figure enables the synonymy of *Chrysura pustulosa* with *radians*. The identity of the other species is impossible to determine.

Whilst examining type-material during the course of this study, it became apparent that a number of lectotype designations were necessary to ensure future nomenclatural stability. I have appropriately labelled all specimens selected as lectotypes. They are as follows.

Chrysis angustula Schenck, 1856: 30. Four conspecific specimens stand under *C. angustula* in the Schenck collection at the Forschungsinstitut Senckenberg, Frankfurt am Main. Three of the specimens are unlabelled; the fourth which I here designate as lectotype, has a probable collection drawer label “*ignita* var. *angustula*”. All specimens conform with current interpretation.

Chrysis bicolor Lepeletier, 1805: 127. I have designated as lectotype the male specimen with its gaster missing as this agrees with current interpretation, sufficient characters being present on the thorax and head to fix its identity. The lectotype is in Muséum National d’Histoire Naturelle, Paris.

Chrysis fulgida Linnaeus, 1761: 415. Linnaeus mentioned two forms of this species, the first of which (a female specimen), he described as “primo segmento caeruleis, reliquis aureis”, and the second (a male specimen) as “abdomine aureo exceptis primo & secundo segmento caeruleo.” Richards (1935) regarded the male as type (= holotype), stating it agreed with modern interpretation. Linnaeus’s label is however currently placed on the female specimen; in which case either Richards misidentified the sex of the type, or the label has been subsequently transferred. Day (1979b) misidentified the sexes, assuming the specimen bearing Linnaeus’s label to be a male after Richards’s interpretation. However, as previously pointed out, the specimen is female. The arguments about which sex fits the description are irrelevant as Linnaeus described both sexes. It is apparent that a lectotype designation is required and I hereby select the female specimen currently bearing Linnaeus’s label and matching the first part of the description. The male as described above is the only paralectotype. Both are in the Linnaean collection, Linnean Society, London.

Chrysis impressa Schenck, 1856: 29. From the description, Schenck saw more than one specimen. Ten specimens have been studied from his collection which is housed at the Forschungsinstitut Senckenberg, Frankfurt am Main. Nine of these specimens are unlabelled *Chrysis angustula*, while the tenth is a female of *C. impressa* bearing what is probably a drawer label “*ignita* L. var. *impressa*”. In the absence of other material, I have designated this specimen as lectotype.

Chrysis longula Abeille de Perrin, 1879: 74. I designate as lectotype the female specimen from Frankfurt am Main collected by Heyden. The lectotype is in the Muséum National d’Histoire Naturelle, Paris.

Chrysis neglecta Shuckard, 1836: 169 (present combination *Spinolia neglecta* (Shuckard)). Though Shuckard’s collection is lost, he probably examined material of this taxon from many contemporary collections, including that of Stephens (Day, 1979a). There are seven specimens of *neglecta* from the Stephens collection in the British Museum (Natural History) collection. I here designate as lectotype a female specimen from this series.

Chrysis pustulosa Abeille de Perrin, 1878: 6 (present combination *Chrysura pustulosa* (Abeille de Perrin)). The female specimen which I have designated as lectotype came from the Collection Générale, Muséum National d’Histoire Naturelle, Paris, although bearing the label “Coll. R. du Buysson 1900”. Other labels indicate it originated in the Abeille

de Perrin Collection. The specimen is labelled 'Cotype', but is the only verifiable syntype available from one of the original localities — Lorgues. I have therefore designated it lectotype.

Chrysis truncatus Dahlbom, 1831: 35 (present combination *Omalus truncatus* (Dahlbom)). From the distribution records Dahlbom saw more than one specimen (from Västergötland and Smaland). I designate as lectotype the male specimen bearing his label "*C. truncata* ♂ nov." from the Dahlbom collection in the Zoological Museum, Lund, Sweden.

Cleptes pallipes Lepelletier, 1805: 119. I here designate as lectotype the female labelled "type" from "environ Paris" and bearing what is probably an old collection drawer label — "*C. Pallipes*". The lectotype is in the Muséum National d'Histoire Naturelle, Paris.

Hedychrum coriaceum Dahlbom, 1854: 88 (present combination *Hedychridium coriaceum* (Dahlbom)). I here designate as lectotype the female specimen bearing Zeller's label and the identification label in Dahlbom's handwriting. From the description other specimens were seen but are now apparently lost. The lectotype is in the Zoological Museum, Lund, Sweden.

Hedychrum rutilans Dahlbom, 1854: 76. I here designate as lectotype the specimen collected by Zeller and identified as "*Hed. rutilans* Megerl. Dahl. var. a.". The lectotype is in the Zoological Museum, Lund, Sweden.

Spheg cyanea Linnaeus, 1758: 572 (present combination *Trichrysis cyanea* (Linnaeus)). Richards (1935) correctly points out that of the three specimens under *cyanea* in the Linnaean Collection, the labelled individual does not agree with the description. Day (1979b) went further and stated that 'the other two specimens associated with the labelled specimen do not agree with the critical qualification "ano tridentato"'. However, a reappraisal of these specimens shows that both are males of *cyanea*, and that both do in fact have "ano tridentato" in the sense of Linnaeus's concept of abdominal apical margin dentition in chrysidid wasps. For instance Linnaeus called *Omalus auratus* "bidentato" when the apical margin has only a small central notch. Also *Chrysis viridula* is called "quadridentato" when centrally it has only obtuse angulations. Besides being "quadridentato" the specimen currently bearing Linnaeus's label does not fit the further description he gives in 1761 — "simillima *C. ignita* sed paulo minor", the specimen being a similar size to *C. ignita*. I have designated as lectotype the male specimen that is in better condition, the second (paralectotype) lacks the head. The lectotype is in the Linnaean collection, Linnean Society, London.

Morphological terminology

Terminology follows Richards (1977); explanations of other specialist morphological terms are given below. Basic terminology is shown in figures 1 to 5.

Apical rim	—	posterior margin of third gastral tergite (area beyond pit-row where present).
BOL	—	brow-ocellar line = shortest distance between the anterior ocellus and the brow, when viewed dorsally, (the brow position is often marked by a carina).
Brow	—	forehead-like swelling between ocelli and scapal basin.
EL	—	eye length at maximum.

- Gaster — abdominal segments forming rear part of body (section separated by petiole).
- Malar space — shortest distance between eye margin and mandible base.
- MPL — mesoscutellum-propodeum length.
- OD — ocular distance = shortest distance between eyes.
- OOL — ocular-ocellar line = shortest distance between a rear ocellus and an eye.
- Pit-row — subapical row of large punctures on the third gastral tergite.
- PPW — propodeum posterior width.
- Scapal basin — area of frons covered by rotation of scapes.

Notes on the keys

Before using the keys it is advisable to read the section on characters and character variation, where details of specific problems are given. Some specimens, when taken in isolation without named material for comparison, may be difficult to identify accurately. General notes are given under the generic headings with biological information when this is characteristic. A generic diagnosis is included, as some recent works have redefined the limits of many genera.

Differentiation of sexes is placed under the generic heading as the characters referred to apply to all species. There are few reliable characters for separating the sexes at species level, but where useful they have been included. In the keys to species, relative abundance is on the following scale; common, moderately common, uncommon, rare, very rare, extremely rare. The terms are based on the relative numbers of specimens in the British Museum (Natural History), with adjustment being made where the study of further material gives additional information. Flight period months are expressed in Roman numerals, and distribution records are summarised. Host records and biologies are included when known. The phrase "reared from" indicates a confirmed record where cells have been taken and occupants captured on emergence. British material can be identified using the key to genera and then the keys to species. A key to the world subfamilies has been included for completeness and to present further information in a useful form. No previous key to the world subfamilies includes all groups. Only three subfamilies are found in Britain, the Cleptinae, Elampinae, and Chrysidinae, with the Parnopinae being present in southern Europe.

Key to world subfamilies

- 1 Gaster with two visible tergites. [African] **Allocoeliinae**
- Gaster with three or more visible tergites 2
- 2 Vertex with posterior prolongation bearing membranous laminae on each side. Similar laminae present on the thorax, tibiae and femora. Antennal insertions lie above a prominent transverse ledge. [Indo-Australian] **Loboscelidiinae**
- Vertex without posterior prolongation. Head and body without membranous laminae. No transverse ledge below antennal insertions 3
- 3 Mouthparts when extended at least as long as head length in full face view. Tegulae large, longer than median dorsal length of pronotum. Posterior corners of gastral tergites strongly to weakly toothed, but teeth always present. [Worldwide] **Parnopinae**
- Mouthparts when extended shorter than head length in full face view. Tegulae shorter than median dorsal length of pronotum. Posterior corners of gastral tergites not toothed . 4
- 4 Gaster with four or more visible tergites, ventral surface convex 5
- Gaster with three visible tergites, ventral surface concave 6

- 5 Length of gastral tergites 1 plus 2 approximately equal to length of gastral tergites 3 plus 4 (fig. 10). Pronotum with transverse anterior groove, always with distinct anterior bulbous collar (fig. 91). [Palearctic, Oriental, Nearctic and Neotropical regions] **Cleptinae**
- Length of gastral tergites 1 plus 2 considerably greater than length of gastral tergites 3 plus 4 (fig. 9). Pronotum usually without transverse anterior groove, always lacking bulbous collar. [Africa, Indo-Australia, Nearctic and Neotropical regions] **Amiseginae**
- 6 Tarsal claws with one or more preapical subsidiary teeth. Radial sector vein of the forewing sclerotised along less than half its possible length to wing margin. Gastral tergite 3 without subapical pit-row, and never more than two apical teeth. Veins surrounding discoidal and cubital cells of forewing mostly lacking (figs 6, 8). [Worldwide] **Elampinae**
- Tarsal claws simple, without preapical subsidiary teeth. Radial sector vein of the forewing sclerotised along more than half its possible length to wing margin. Gastral tergite 3 mostly with subapical pit-row (where absent has four apical teeth). Veins surrounding discoidal and cubital cells of forewing usually completely sclerotised (figs 5, 7). [Worldwide] **Chrysidinae**

Key to genera

- 1 Gaster with four or more visible tergites, ventral surface convex. Pronotum with transverse anterior groove bounded by distinct anterior bulbous collar (figs 10,91) . **Cleptes** (p.13)
- Gaster with three visible tergites, ventral surface concave. Pronotum without anterior bulbous collar. (figs 1, 4, 93) 2
- 2 Claws either forked at tip, or with several teeth behind apex, or with one very small median tooth (figs 11, 12, 13). Discoidal cell absent, or considerably less distinct than other cells in forewing, veins around it either lacking pigment or poorly developed (figs 6, 8). Lateral edges of metapleuron and propodeum continuous (figs 14, 15) 3
- Claws simple, with no additional teeth behind apex. Discoidal cell as distinct as other cells in forewing (fig. 5). Lateral edges of metapleuron and propodeum interrupted at spiracle and forming small metapleural tooth (fig. 16) 7
- 3 Claws with more than one tooth behind apex (fig. 11) 4
- Claws with single tooth behind apex (figs 12, 13) 6
- 4 Third gastral tergite notched posteromedially. Forewings without discoidal cell; medial vein at most slightly curved (fig. 8) 5
- Third gastral tergite without posteromedial notch. Forewings with faintly defined discoidal cell; outer surrounding veins lacking pigment; medial vein almost right-angled near mid-point (fig. 6) **Holopyga** (p.17)
- 5 Metanotum posterodorsally produced to form horizontal tongue-like flange (fig.92). Posteromedian notch of third gastral tergite with wide horse-shoe shaped prominent rim which is at least as wide as depth of notch **Elampus** (p.14)
- Metanotum posterodorsally without tongue-like flange. Posteromedian notch of third gastral tergite with at most a narrow triangular rim, which if present is much narrower than depth of notch **Omalus** (p.15)
- 6 Claws with second tooth almost as large as apical and very close to it, so that tip appears forked (fig. 12) **Hedychrum** (p.16)
- Claws with very small median tooth (fig. 13) which is widely separated from apex, without forked appearance **Hedychridium** (p.16)
- 7 Posterior margin of third gastral tergite with angular prominences or conspicuous teeth. 8
- Posterior margin of third gastral tergite smooth, shallowly concave to evenly convex but without teeth or angular prominences 9
- 8 Posterior margin of third gastral tergite with three teeth, median tooth centrally placed. Dark patches of second gastral sternite small and close together (fig. 17). **Trichrysis** (p.19)
- Posterior margin of third gastral tergite without three teeth, and without centrally placed tooth. Dark patches of second gastral sternite not as above (fig. 3) **Chrysis** (p.20)

- 9 In full face view antennal sockets positioned on line connecting lower margins of eyes. Radial sector vein terminates before forewing margin, at distance approximately equal to length of pterostigma (fig. 7) **Spinolia** (p.18)
- In full face view antennal sockets distinctly below line connecting lower margins of eyes. Radial sector vein reaching forewing margin, or nearly so (fig. 5) 10
- 10 Genal carina extends well above lower margin of eye (fig. 18). In profile dorsal surface of thorax forms single continuous curved surface (fig. 23) **Chrysogona** (p.20)
- If present, genal carina does not extend above lower margin of eye (fig. 19). In profile dorsal surface of thorax distinctly undulate, not forming single continuous curved surface (fig. 22) **Chrysura** (p.19)

Subfamily Cleptinae

The Cleptinae is regarded as the most primitive group in the Chrysididae, with approximately 50 described species found in the Palaearctic and Oriental regions and North and South America. The subfamily is represented by a single genus in Britain, *Cleptes*. Cleptinae do not adopt the rolled defensive position of the Chrysidinae, although the sides of the thorax are shaped to allow the legs to lie closely against it. The gaster is convex beneath and has four visible segments in the female and five visible segments in the male. The pronotum is narrowed anteriorly, with a transverse crenate sulcus producing a bulbous anterior collar. The lateral edges of the propodeum and metapleuron are continuous. The forewing either lacks or has a weakly defined discoidal cell, and has a shortened radial sector vein. The tarsal claws are dentate with a single tooth. The clypeus is medially produced; the maxillary palpi are five-segmented; the labial palpi three-segmented. *Cleptes* species attack sawfly larvae or pupae in their cocoons.

Genus *Cleptes* Latreille (figs 10, 91)

This is an easily recognised genus, containing some very attractively coloured wasps found in the Palaearctic and Oriental regions and in North and South America. According to Richards (1977) the two British cleptine species attack sawfly cocoons. Perkins (1923) had previously pointed out that *C. pallipes* (= *semiauratus*) is frequently found in domestic gardens where it parasitises the common currant-sawfly *Nematus ribesii* Scopoli, a species having up to three broods a year between April and September, and a well known pest of *Ribes rubrum*, *R. uva-crispa*, and *R. alpinum*. Adult females of *Cleptes* spend a great deal of time seeking out sawfly cocoons either on the host's food-plant or on the ground beneath. In the currant-sawfly summer cocoons are often spun amongst the leaves, with only the over-wintering generations spinning cocoons in the soil. When a suitable sawfly cocoon is found the female *Cleptes* bites a small crescent-shaped hole near one end and inserts her ovipositor. An egg is placed on the host inside. The hole is then sealed with mucilage, forming a hard glistening spot, before the cocoon is abandoned. Clausen (1940) states that the host prepupa is killed before the pupal ecdysis and that the cycle length of *Cleptes* from egg to adult is about five weeks, making possible a number of generations each year. A study of the life cycle of *Cleptes semiauratus* preying upon *Pristiphora abietina* (Christ) has been made by Gauss (1964).

Generic diagnosis: pronotum with transverse anterior groove bounded by distinct anterior bulbous collar. Gaster with four or five visible tergites, ventral surface convex.

Differentiation of sexes: the sexes can be separated by the number of visible gastral tergites, four in the female and five in the male. The female antennae are shorter, with a number of segments as broad as long; males have longer antennae with all segments noticeably longer than broad.

Key to species

- 1 Pronotum, immediately in front of posterior margin, with continuous transverse deep row of punctures (fig. 91). (Females, head and thorax mostly copper-red to violet, legs and anterior part of gaster transparent light orange-brown. Gaster apically black with blue reflections. Males, head and thorax blue-black with greenish pronotum; gaster similar to female, though dark apex extends over larger area.) **semiauratus** (Linnaeus)
England: widely distributed in south, with records also from South Yorkshire, Lincolnshire and Leicestershire. Wales: south. Moderately common. vi—viii. Host: Nematus ribesii Scopoli. (Tenthredinidae).
- Pronotum, immediately in front of posterior margin, without row of punctures. (Females, head and mesoscutum black; pronotum and anterior gaster transparent orange-brown; posterior thorax blue. Posterior gaster black with blue reflections. Males, head and thorax blue-black; gaster as female.) **nitidulus** (Fabricius)
England: Devon, Buckinghamshire, Dorset, Hampshire, Berkshire, Cornwall, Lancashire, Merseyside, Cumbria. Uncommon. vi—viii. Often found in stable dune localities with Salix species. Host: Unknown in Britain; reared from Caliroa cerasi (L.) (Tenthredinidae) in France.

Subfamily Elampinae

Elampinae is worldwide in distribution with about 625 described species. This subfamily is represented by 4 genera in Britain, namely *Elampus*, *Hedychridium*, *Hedychrum*, and *Omalus*. An additional genus, *Holopyga*, has a single species present in the Channel Islands. Hosts include Sphecidae and Eumenidae. Adult wasps can adopt the rolled defensive position described for Chrysidinae. Tarsal claws usually have one or more preapical subsidiary teeth. The radial sector vein of the forewing is sclerotised for less than half the length of the marginal cell; the discoidal cell is absent or at most only weakly indicated. The gaster has three visible segments; the third tergite is without a pit row or grooves subapically; the ventral surface of the gaster is flat to concave. The lateral edges of the propodeum and metapleuron are continuous, not interrupted at the spiracle to form a tooth. The frons is often strongly concave.

Genus *Elampus* Spinola (fig. 92)

There are about 40 described species in the genus, which is worldwide except for Australia. There is a single species in Britain, which is associated with stem-nesting pemphredonine sphecids in continental Europe, but observations supporting this in Britain need confirmation (Spooner, 1948).

Generic diagnosis: immediately diagnosed by metanotum being produced posterodorsally to form horizontal tongue-like flange. Posteromedian notch of gaster with prominent rim forming truncation. Wings without discoidal cell. Tarsal claws with more than one tooth.

Differentiation of sexes: viewed ventrally, female gaster tapers posteriorly, while that of male is more rounded. Males usually with only three sternites visible; females with at least four. Most species exhibit genal dimorphism. Females with row of short, dense, regular, bristles on genae, males with long, sparse, irregular hairs; this is clearly seen in sole British species, *E. panzeri*.

- Malar space very small, less than half mandible base width. Gena extremely narrow at lower margin of eye, less than 0.25 times widest point behind eyes. (Head and thorax blue-green, gaster red.) **panzeri** (Fabricius)
England: found throughout the south to South Yorkshire. Moderately common. vi—viii.
Hosts: Psen (Mimesa) species (Sphecidae) nesting in sandy soil.

Genus **Omalus** Panzer

(figs 8, 11, 20, 21, 24, 25, 26, 27)

Five species of this worldwide genus are found in Britain, from over a hundred described species. They are all small wasps which parasitise stem- and wood-nesting Sphecidae. Danks (1971) observed that the larva of *Omalus auratus* consumed its host's food-store, which is of interest because this can range from aphids and flies to spiders. Two of the British species, *Omalus aeneus* and *Omalus auratus* are found in the United States. Bohart & Kimsey (1982) speculate that they may have been introduced through the importation of roses, possibly as early as the 16th or 17th centuries. Danks (1971) has figured the cocoon of *Omalus auratus*.

Generic diagnosis: third gastral tergite with posteromedian notch. Tarsal claws with more than one tooth. Forewings without discoidal cell, and medial vein strongly curved.

Differentiation of sexes (sex determination is extremely difficult without dissection at the genus level, but various species do show slight sexual dimorphism): male of *Omalus auratus* with close, fine, punctures with short hairs fairly evenly distributed over third gastral sternite; female with more dispersed punctures apically with large shiny interstitial areas.

Key to species

- 1 Posterior of third gastral tergite vertically truncated above central notch. Malar space less than half basal width of mandible. (Head, thorax and anterior gaster violet; posterior gaster blue-green with violet.) **truncatus** (Dahlbom)
England: Berkshire, Surrey, Dorset, Essex, London, Kent. Extremely rare. vi. Host: Unknown.
- Posterior of third gastral tergite without vertical truncation, merely with simple apical notch. Malar space larger than half basal width of mandible 2
- 2 In profile, side of mesopleuron produced anteriorly, obscuring anteroventral surface (fig. 27). Dorsal surfaces of mesothorax, metathorax and propodeum with numerous hairs, which are longer than antennal segment four. In dorsal view front edge of brow deeply curved (fig. 21) 3
- In profile, side of mesopleuron not produced anteriorly, instead ending in sharp oblique carina, anteroventral surface clearly visible (fig. 26). Dorsal surfaces of mesothorax, metathorax and propodeum with few hairs, which are much shorter than antennal segment four. In dorsal view front edge of brow only slightly curved (fig. 20) 4
- 3 Posteromedian notch of third gastral tergite about as wide as deep. Gaster red. (Head and thorax blue with green; gaster red with green tints.) **auratus** (Linnaeus)
England: Cornwall to Kent, north to North Yorkshire and Lancashire. Wales. Ireland. Channel Islands: Jersey. Common. iv—viii. Hosts: reared from Pemphredon lethifer (Shuckard), P. inornata Say (nest in cut stems, usually Rubus), Passaloecus gracilis (Curtis), Rhopalum coarctatum (Scopoli), Trypoxylon species (all Sphecidae nesting in dead wood or cut stems).
- Posteromedian notch of third gastral tergite a shallow obtuse indentation, wider than deep. Gaster violet. (Entire body violet with green.) **violaceus** (Scopoli)
England: East and West Sussex, Hampshire, London, Somerset, Berkshire, Suffolk, Devon, Kent, Leicestershire. Uncommon. iv—viii. Hosts: reared from Pemphredon lugubris (Fabricius) (Sphecidae) nest in rotten wood, Passaloecus corniger (Shuckard) (Sphecidae) nests in Lipara galls and dead wood.

- 4 Pronotum and mesonotum dorsomedially very shiny, without large punctures (fig. 24). OOL approximately equals BOL. (Body predominantly green and blue.) **aeneus** (Fabricius)
England: widespread, as far north as South Yorkshire. Moderately common. v—viii. Hosts: stem- and wood-nesting Sphecidae of subfamily Pemphredoninae.
- Pronotum and mesonotum dorsomedially with scattered but conspicuous large punctures (fig. 25). OOL at least 1.5 times BOL. (Body violet with green.) **puncticollis** (Mocsáry)
England: Hampshire, Devon, Surrey, Northamptonshire, Somerset, Buckinghamshire, Dorset, Berkshire, Staffordshire. Rare. vi—viii. Host: Unknown, collected from dead larch.

Genus **Hedychrum** Latreille

(figs 12, 30, 31)

This genus is represented by two species in Britain. *Hedychrum* species are distributed through the Palaearctic and Oriental regions, Africa, and North and South America. There are approximately 100 described species. Adults are found at the burrows of sphecid wasps in soil and sandy banks.

Generic diagnosis: tarsal claws with large tooth near apex, giving forked appearance to claw. Hind tibiae and sometimes mid tibiae with pit or groove on posterior surface towards apex.

Differentiation of sexes: males with evenly rounded posterior to gaster and only three visible gastral sternites. Females with more tapered posterior to gaster and at least four visible sternites; also posterior edge of third gastral sternite concave (in some species very deeply) with small central thickening which may form a peg in some species.

Key to species

- 1 Lateral edge of third gastral tergite with right-angled tooth (fig. 31). Hairs on head and thorax pale. Punctures on third gastral tergite mostly circular, evenly spaced, the distance separating them about equal to diameter of punctures. (Head and thorax green and blue; gaster red.) **rutilans** Dahlbom
*England: Hampshire, London?. Channel Islands: Jersey. Extremely rare. viii. Host: Unconfirmed in Britain. In Europe recorded from *Philanthus triangulum* (Fabricius) and *P. coronatus* (Fabricius) (Sphecidae).*
- Lateral edge of third gastral tergite with only small rounded prominence (fig. 30.) Hairs on head and thorax dark brown to black. Punctures on third gastral tergite ovoid, unevenly spaced, frequently the diameter of punctures greater than distance separating them. (Head and thorax green with blue; gaster red.) **niemelai** Linsenmaier
*England: Cornwall, Devon, Dorset, Hampshire, Kent, Berkshire, Suffolk, Essex, London, Norfolk. Common. vii—viii. Hosts: *Cerceris ruficornis* (Fabricius), *C. arenaria* (L.), *C. rbyensis* (L.), and *C. quinquefasciata* (Rossi) (Sphecidae).*

Genus **Hedychridium** Abeille de Perrin

(figs 13, 15, 28, 29, 78, 79)

This is the second largest elampine genus found in Britain, with approximately 150 described species worldwide, from the Palaearctic and Oriental regions, Africa, and North and South America. The four British species of this genus parasitise ground-nesting Sphecidae, particularly in sandy localities.

Generic diagnosis: tarsal claws with very small median tooth and apex of third gastral tergite evenly rounded. Hind tibiae lack pit or groove.

Differentiation of sexes (sex determination is extremely difficult without dissection): generally gastral apex in males more broadly rounded than in females. The difference becomes more apparent with experience (figs 78, 79).

Key to species

- 1 Mesoscutum with widely scattered punctures, broad spaces between glassy smooth; mesoscutum conspicuously less densely and coarsely sculptured than propodeal dorsum. (Head and thorax dark olive green; gaster red-purple with blue-green reflections.)..... **cupreum** (Dahlbom)
England: Dorset, Surrey, Suffolk, Hampshire, Cheshire, Berkshire, Norfolk, Oxfordshire, Lancashire. Wales: South Glamorgan, Anglesey. Uncommon. vii—viii. Host: Astatia pinguis (Dahlbom) (Sphecidae).
- Mesoscutum with closely-packed punctures which are adjacent and not separated by broad smooth spaces; mesoscutum almost or quite as densely and coarsely sculptured as propodeal dorsum 2
- 2 Gaster dull orange (fades to brown in older specimens) without metallic colours or reflections. Scapal basin strongly transversely striate, striate area each side of mid-line about equal to width of scape (fig. 29). (Head and thorax blue with green areas; gaster dull orange.) **roseum** (Rossi)
Widely distributed throughout England. Channel Islands. Moderately common. vi—viii. Hosts: Astatia boops (Schränk), Tachysphex pompiliformis (Panzer), Gorytes tumidus (Panzer) (Sphecidae).
- Gaster never dull orange, always with bright metallic colours and reflections. Scapal basin weakly and sparsely striate, striate area each side of mid-line less than width of scape (fig. 28) 3
- 3 Punctuation of pronotum, mesoscutum and mesoscutellum coriaceous with distinct rugae formed by alignment of puncture margins. Malar space length less than basal width of mandible. (Head and anterior thorax red with green tints; metanotum and propodeum blue. Gaster red.) **coriaceum** (Dahlbom)
England: Devon, Dorset, Surrey, Hampshire, Isle of Wight, Lancashire. Uncommon. vi—viii. Host: Lindenius albilabris (Fabricius) (Sphecidae).
- Punctuation of pronotum, mesoscutum, and mesoscutellum separated, without rugae formed by alignment of puncture margins. Malar space length equal to basal width of mandible. (Head and thorax red and green; lateral parts of metanotum and propodeum green or blue; gaster red.) **ardens** (Latreille)
Distributed throughout British Isles. Channel Islands: Guernsey. Moderately common. vi—viii. Host: Tachysphex pompiliformis (Panzer) (Sphecidae).

Genus **Holopyga** Dahlbom

(fig 6)

The genus is represented by a single species in the Channel Islands only. About 80 species have been described from the Palearctic and Oriental regions, Africa, and North and South America.

Generic diagnosis: medial vein in forewing almost right-angled near to mid-point (fig. 6). Tarsal claws with teeth.

Differentiation of sexes: in males both posterior of third gastral tergite and posterior edge of third gastral sternite broadly rounded. In females, posterior of third gastral tergite tapers, and posterior edge of third gastral sternite concave, fourth sternite clearly showing.

— Anterior face of first gastral tergite with basal striations. Punctuation of second and third gastral tergites of similar size. (Head and thorax blue with green areas; gaster red.) **ovata** Dahlbom
Channel Islands: Jersey. Moderately common. vi—viii. Host: Unknown.

Subfamily Chrysidinae

Five British genera occur in this subfamily, namely *Chrysis*, *Chrysozona*, *Chrysurus*, *Spinolia* and *Trichrysis*. The subfamily is worldwide with about 2250 described species. Ventrally the gaster is concave allowing the insects to take up a characteristic rolled defensive position (fig. 86). The radial sector vein of the forewing extends more than half the length of the marginal cell and veins bordering the discoidal and cubital cells are usually complete and the cells clearly defined. The third gastral tergite has a sub-apical pit-row or groove and often a dentate posterior margin. Tarsal claws are simple, without teeth. The lateral edges of propodeum and metapleuron are interrupted at the spiracle.

In Britain, hosts include Eumenidae, Sphecidae, and Megachilidae. Once a chrysidine female has located a host female constructing a nest, she will successively oviposit as new host cells are constructed. Although oviposition usually occurs in unsealed cells during, or shortly after provisioning by the host, some chrysidids are known to break through partitions to gain access to cells (Isely, 1913; Chevalier, 1931). Oviposition is quick, taking only a few seconds (Danks, 1971) because it has to be accomplished between host visits (Jorgensen, 1942). Sometimes chrysidids will fight amongst themselves for the same host nest until a single female is successful (Jorgensen, 1942). Else (personal communication) has observed that females enter head-first to inspect the host nest, then emerge, turn round and reverse into the nest to oviposit. In the study by Danks (1971) on stem-nesting aculeates, up to four eggs of *Trichrysis cyanea* were laid in the same cell. In these cases the chrysidid larvae which hatched first consumed the other chrysidid eggs as well as the host egg, before beginning to eat the spider prey collected by the *Trypoxylon* host. Danks figured the egg and first instar larva of *Trichrysis cyanea*.

Genus *Spinolia* Dahlbom

(figs 7, 82, 83, 89)

An easily recognisable genus, represented by a single species in Britain, *neglecta*. Until recently this was placed in the genus *Euchroeus*, subgenus *Pseudospinolia*. *Pseudospinolia* was raised to generic level by Bohart & Kimsey (1980). However Kimsey (1983) states that this was premature and has now synonymised *Pseudospinolia* with *Spinolia*. The genus contains about fifteen species and is distributed through the Palaearctic and Oriental regions, with an introduced species in North America. In France, Maneval (1932) found that the first instar larva of *Spinolia neglecta* penetrated the body of the partly developed host larva of *Osmia villosa* Schenck, and then grew coincidentally with it (fig. 89). At the end of 20 days the chrysidid larva had completely consumed the host larva.

Generic diagnosis: marginal cell of forewing widely open; discoidal cell of characteristic shape (fig. 7). Gastral tergite 3 with smoothly rounded apical margin.

Differentiation of sexes: in female, gaster tapers posteriorly; in male gaster more shallowly curved posteriorly (figs 82, 83).

- Gaster with distinct irregular coalescing punctures giving matt effect. Extended mouthparts longer than scape. (Head and thorax blue, gaster red.) ***neglecta*** (Shuckard)
England: southern counties with records also from Nottinghamshire and Cambridgeshire. Wales: South Glamorgan. Moderately common. v—vii. Host: Odynerus spinipes (L.) (Eumenidae) nests in vertical sandy faces.

Genus *Trichrysis* Lichtenstein (fig. 17)

This genus is represented by a single species which is one of the commonest chrysidids found in Britain. Until recently of subgeneric rank in the genus *Chrysis*, *Trichrysis* was raised to generic level by Bohart & Kimsey (1980).

Generic diagnosis: third gastral tergite with pit-row and apical rim which has either three teeth or three angulations. Head with transverse brow carina.

Differentiation of sexes: in profile, gastral tergite 3 convex in female, concave in male.

- Third gastral tergite with three distinct teeth. Black patches of second gastral sternite small and coalescing (fig. 17). (Entire body blue with green patches.) *cyanea* (Linnaeus)
Distributed throughout England. Wales: South Glamorgan. Common. v-ix. Hosts: reared from Trypoxylon figulus (L.), and T. attenuatum Smith (Sphecidae). Other records — Pemphredon (Cemonus) species (Sphecidae) and Chelostoma florissomne (L.) (Megachilidae).

Genus *Chrysura* Dahlbom (figs 19, 22, 72, 73, 84, 85, 88, 90)

Represented by two species in Britain; one is northern, virtually confined to Scotland, the other is southern, occurring only in England and Wales. Forty species have been described from North America and the Palaearctic region; all are parasitic on megachilid bees.

A study by Krombein (1967), which covered some of the North American species, found that the chrysidid larva usually hatched a day later than the host bee and sometimes consumed a small amount of "nectar". About 3-7 days after hatching, the *Chrysura* larva attached itself to the feeding bee larva and slowly began to consume it. The host bee larva began to spin its cocoon 17-31 days after hatching. As soon as the host cocoon was completed and the bee larva quiescent, the *Chrysura* larva then moulted to the second instar and then completely devoured the host. The *Chrysura* larva then spun its cocoon inside that of the bee. Cocoons of *Osmia inermis* Zetterstedt parasitised by *Chrysura hirsuta* in Britain were found to support these observations (fig. 88).

Generic diagnosis: apical margin of third gastral tergite evenly curved. Head without brow carina and of characteristic shape. Genal carina not extending above lower margin of eyes. In profile dorsal surface of thorax distinctly undulate.

Differentiation of sexes: males with ventral swellings on various flagellar segments; this character not present in females. Also male third gastral tergite wider and more rounded posteriorly than in female and apical rim narrower (figs 72, 73).

Key to species

- 1 Larger punctures on first gastral tergite same size as those on pronotum. Mid and fore tibiae without black hairs. Viewed dorsally, metapleuron with prominence but without distinct tooth (fig. 84). (Head and thorax blue, gaster red.) *radians* (Harris)
England and Wales to North Yorkshire and Cumberland. Moderately common. v-vii. Hosts: wood-boring species of Osmia; possibly Osmia leaiana (Kirby) (Megachilidae).
- Larger punctures on first gastral tergite about half size those on pronotum. Mid and fore tibiae with thick black hairs. Viewed dorsally, metapleuron with distinct tooth (fig. 85). (Head and thorax blue with green, gaster red.) *hirsuta* (Gerstäcker)
Scotland: Grampian Highlands, Dumfries and Galloway. Uncommon. v-vi. Host: reared from cells of Osmia inermis Zetterstedt (Megachilidae) (fig. 88), found in exposed mountain areas.

References

- ABEILLE de PERRIN, E. 1878. *Diagnoses de Chrysidés nouvelles*. Société Entomologique de France, Bibliothèque. 6pp. Marseille.
- . 1879. Synopsis critique et synonymique des Chrysidés de France. *Annales de la Société Linnéenne de Lyon*. **26**: 1-132.
- ARNOLD, G. 1910. The Host of *Hedychridium coriaceum*, Dhb. *Entomologist's Monthly Magazine*. **46**: 18-19.
- ATANASSOV, N. 1940. Beitrag zum Studium der Goldwespen bulgariens. *Izvestiya na Bulgarskoto Entomologichno Druzhestvo*. **11**: 203-216.
- BALTHASAR, V. 1951. Monographie des Chrysidides de Palestine et pays limitrophes. *Acta Entomologica Musei Nationalis Pragae*. **27** (2): 1-317.
- . 1953. Une contribution à la connaissance des Hyménoptères aculéates de Slovaquie. [In Czech with French summary.] *Câsopis České Společnosti Entomologické*. **50**: 180-187.
- BENNO, P. 1950. De nederlandse goudwespen en haar verspreiding (Hym. Chrysididae, Cleptidae). *Publicatiën van het Natuurhistorisch Genootschap in Limburg*. **3**: 9-48.
- BERLAND, L. & BERNARD, F. 1938. Hyménoptères Vespiformes. III (Cleptidae, Chrysididae, Trigonalidae). *Faune de France*. **34**: i-vii, 1-145.
- BOHART, R.M. & KIMSEY, L.S. 1980. A generic synopsis of the Chrysididae of America north of Mexico (Hymenoptera). *Journal of the Kansas Entomological Society*. **53**: 137-148.
- . 1982. A synopsis of the Chrysididae in America north of Mexico. *Memoirs of the American Entomological Institute*. **33**: 1-266.
- BUYSSON, R. du. 1891-1896. Chrysididae In André, E. [Editor] *Species des Hyménoptères d'Europe & d'Algérie*. **6**: 758pp. Gray.
- CHAPMAN, T.A. 1869. On the chrysidés parasitic on *Odynerus spinipes*. *Transactions of the Woolhope Naturalists' Field Club. Hereford*. 99-104.
- CHEVALIER, L. 1931. *Chrysis ignita*. L. mangeur de chenilles de microlepidopteres. *Bulletin (et Mémoires) de la Société des Sciences Naturelles et Médicales de Seine-et-Oise*. **12**: 10-24.
- CLAUSEN, C.P. 1940. *Entomophagous insects*. 688pp. London & New York.
- DAHLBOM, A.G. 1831. *Exercitationes Hymenopterologicae. III. Monographia Chrysididum Sveciae*. 17pp. Lund.
- . 1845. *Dispositio Methodica, Specierum Hymenopterorum II*. 20pp. Lund.
- . 1854. *Hymenoptera Europaea II. Chrysis (in sensu Linnaeano)*. 412pp. Lund.
- DANKS, H.V. 1971. Biology of some stem-nesting aculeate Hymenoptera. *Transactions of the Royal Entomological Society of London*. **122**. 323-399.
- DAY, M.C. 1977. A New Genus of Plumariidae from Southern Africa with notes on Scolebythidae (Hymenoptera: Chrysoidea). *Cimbebasia* (A) **4**: 171-177.
- . 1979a. Nomenclatural studies on the British Pompilidae (Hymenoptera). *Bulletin of the British Museum (Natural History) (Ent.)*. **38**(1): 1-26.
- . 1979b. The species of Hymenoptera described by Linnaeus in the genera *Sphex*, *Chrysis*, *Vespa*, *Apis* and *Mutilla*. *Biological Journal of the Linnean Society*. **12**: 45-84.
- GAUSS, R. 1964. *Cleptes semiauratus* L. (Hym. Chrysididae) im Rahmen der Parasitenliste von *Pristiphora abietina* (Christ) (Hym. Tenthredinidae) in Südwestdeutschland. *Zeitschrift für Angewandte Entomologie*. **54**: 225-232.
- HALLETT, H.M. 1928. The Hymenoptera Aculeata of Glamorgan. *Transactions of the Cardiff Naturalists' Society*. **60**: 33-67.
- HARRIS, M. 1776-1780. *An Exposition of English Insects*. 166pp. London.
- HAUPT, H. 1956. Die Unechten und Echten Goldwespen Mitteleuropas (*Cleptes* et Chrysididae). *Abhandlungen und Berichte aus dem Staatlichen Museum für Tierkunde in Dresden*. **23**(1): 15-139.
- ISELY, D. 1913. The biology of some Kansas Eumenidae. *Kansas University Science Bulletin*. **8**(7): 235-309.
- JONES, H.P. 1933. The Aculeate Hymenoptera of Hampshire: Supplementary list. *Transactions of the Entomological Society of the South of England*. **8**(2): 108-116.
- JORGENSEN, P. 1942. Biological observations on some solitary vespides. *Entomologiske Meddelelser*. **22**: 299-335.

- KIMSEY, L.S. 1983. Review of the Euchroeine Chrysidids (Hymenoptera: Chrysididae). *Pan-Pacific Entomologist*. **59**: 140-147.
- KLOET, G.S. & HINCKS, W.D. 1978. A Check List of British Insects (2nd edition). Part 4, Hymenoptera. *Handbooks for the Identification of British Insects*. **11**: i—ix, 1-159.
- KROMBEIN, K.V. 1967. *Trap-Nesting Wasps and Bees: Life Histories, Nests, and Associates*. 570pp. Washington.
- LEPELETIER, A. 1805. Sur quelques espèces nouvelles d'insectes de la section des Hyménoptères appelés les Portetuyaux, et sur les caractères de cette famille et des genres qui la composent. *Annales du Muséum National d'Histoire Naturelle*. **7**(1806): 119-127.
- LICHTENSTEIN, J. 1876. Note sur le genre *Chrysis*. *Petites Nouvelles Entomologiques*. **2**(145): 27.
- LINNAEUS, C. 1758. *Systema Naturae*. **1** (10th. ed.) 824pp. Stockholm.
- _____. 1761. *Fauna Suecica*. (ed. altera.) 578pp. Stockholm.
- LINSENMAIER, W. 1959. Revision der Familie Chrysididae (Hymenoptera). *Mitteilungen der Schweizerischen Entomologischen Gesellschaft*. **32**: 1-232.
- _____. 1968. Revision der Familie Chrysididae (Hymenoptera) Zweiter Nachtrag. *Mitteilungen der Schweizerischen Entomologischen Gesellschaft*. **41**: 1-144.
- LORENCOWA, J. 1962. Morphological properties of the family Chrysididae and of Polish species of *Hedychrum* Latr. based on the structure of the retracted abdomen segments of females. *Polskie Pismo Entomologiczne*. **32**: 151-189.
- MANEVAL, H. 1932. Notes recueillies sur les Hyménoptères. *Annales de la Société Entomologique de France*. **101**: 85-86.
- MÓCZÁR, L. 1964. Ergebnisse der Revision der Goldwespenfauna des Karpatenbeckens. (Hymenoptera: Chrysididae). *Acta Zoologica, Academiae Scientiarum Hungaricae*. **10**: 433-450.
- _____. 1967. Fémendarázs — Alkatúak — Chrysidoida. *Fauna Hungariae (Hymenoptera III)*. **86**: 1-118.
- MOCSÁRY, A. 1889. *Monographia Chrysididarum, Orbis Terrarum Universi*. 643pp. Budapest.
- MORICE, F.D. 1896. An annotated revision of the British Chrysididae. *Entomologist's Monthly Magazine*. **32**: 116-127.
- _____. 1897. A New British Chrysid: *Hedychridium coriaceum* Dhb. *Entomologist's Monthly Magazine*. **33**: 181.
- _____. 1900. *Ellampus truncatus* Dahl. an addition to the list of British Chrysidids. *Entomologist's Monthly Magazine*. **36**: 107-108.
- _____. 1900. A key to British Chrysidids. *Entomologist's Monthly Magazine*. **36**: 129-131.
- _____. 1901. Two unrecorded British Hymenoptera, *Hedychrum rutilans* Dahl. and *Salix propinquus* Lep.. *Entomologist's Monthly Magazine*. **37**: 247.
- _____. 1902. *Ellampus truncatus* Dahl. confirmed as British. *Entomologist's Monthly Magazine*. **38**: 170.
- NOSKIEWICZ, J. & LORENCOWA, J. 1963. Dir verdeckten Segmente der Gruppe *Chrysis ignita* L. (Hymenoptera, Chrysididae). *Polskie Pismo Entomologiczne*. **33**: 119-160.
- NOSKIEWICZ, J. & PULAWSKI, W. 1958. Hymenoptera-Chrysididae, Cleptidae. *Keys for the identification of Polish insects*. [In Polish]. **24**:(55-56): 3-65.
- PERKINS, R.C.L. 1923. The Aculeate Hymenoptera of Devon. *Report and Transactions of the Devonshire Association for the Advancement of Science, Literature, and Art*. **55**: 188-241.
- PERKINS, J.F. 1976. Hymenoptera: Bethyloidea (excluding Chrysididae). *Handbooks for the Identification of British Insects*. **6**:(3a): 1-38.
- RICHARDS, O.W. 1935. Notes on the nomenclature of the aculeate Hymenoptera, with special reference to British genera and species. *Transactions of the Royal Entomological Society of London*. **83**: 158-159.
- _____. 1977. Hymenoptera, Introduction and Key to Families. *Handbooks for the Identification of British Insects*. **6**(1): 1-100.
- SCHENCK, A. 1856. Beschreibung der im Nassau aufgefundenen Goldwespen (Chrysididae). *Jahrbuch des Vereins für Naturkunde im Herzogthum Nassau*. **11**: 13-89.
- SEMENOV-TYAN-SHANSKII, A.P. 1967. New species of gold-wasps (Hymenoptera, Chrysididae) [in Russian]. *Trudy Zoologicheskogo Instituta Akademiya Nauk SSSR*. **43**: 118-184.
- SHUCKARD, W.E. 1836. Description of the Genera and Species of the British Chrysididae. *Entomological Magazine*. **4**: 156-177.
- STELFOX, A.W. 1927. A List of the Hymenoptera Aculeata (Sensu Lato) of Ireland. *Proceedings of the Royal Irish Academy*. **37**: 329-331.

- SPOONER, G.M. 1948. The British Species of Psenine Wasps (Hymenoptera: Sphecidae). *Transactions of the Royal Entomological Society of London*. **99**: 129-172.
- _____ 1954. Notes on species of *Omalus* (Hym., Chrysididae) including one new to the British list. *Entomologist's Monthly Magazine*. **90**: 135-138.
- TRAUTMANN, W. 1927. *Die Goldwespen Europas*. 194pp. Weimar.
- VALKEILA, E. 1971. Two new North European species of the genus *Chrysis* Linnaeus (Hym., Chrysididae). *Entomologisk Tidskrift*. **92**: 82-86.
- YAMANE, S. 1976. Mature larva of *Chrysis ignita* Linné (Hymenoptera: Chrysididae). *New Entomologist*. **25**(3.4): 21-24.

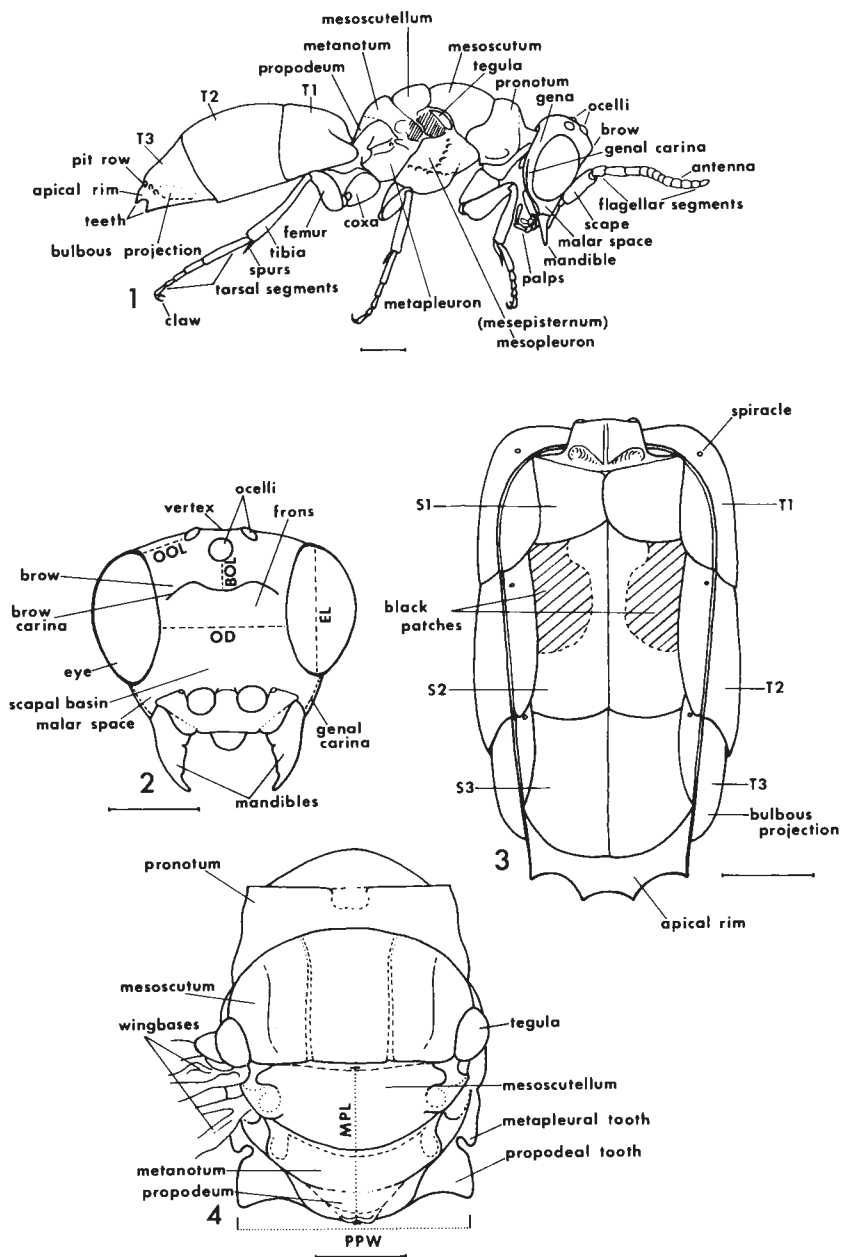

Figs 1-4. *Chrysis ignita* female. 1, lateral view (wings omitted). 2, head in full-face view. 3, gaster ventral view. 4, thorax dorsal view. BOL, brow-ocellar line. EL, eye length. MPL, mesoscutellum-propodeum length. OD, ocular distance (shortest, between eyes). OOL, ocular-ocellar line. PPW, propodeum posterior width. S, gastral sternites. T, gastral tergites. Scale lines represent one millimetre.

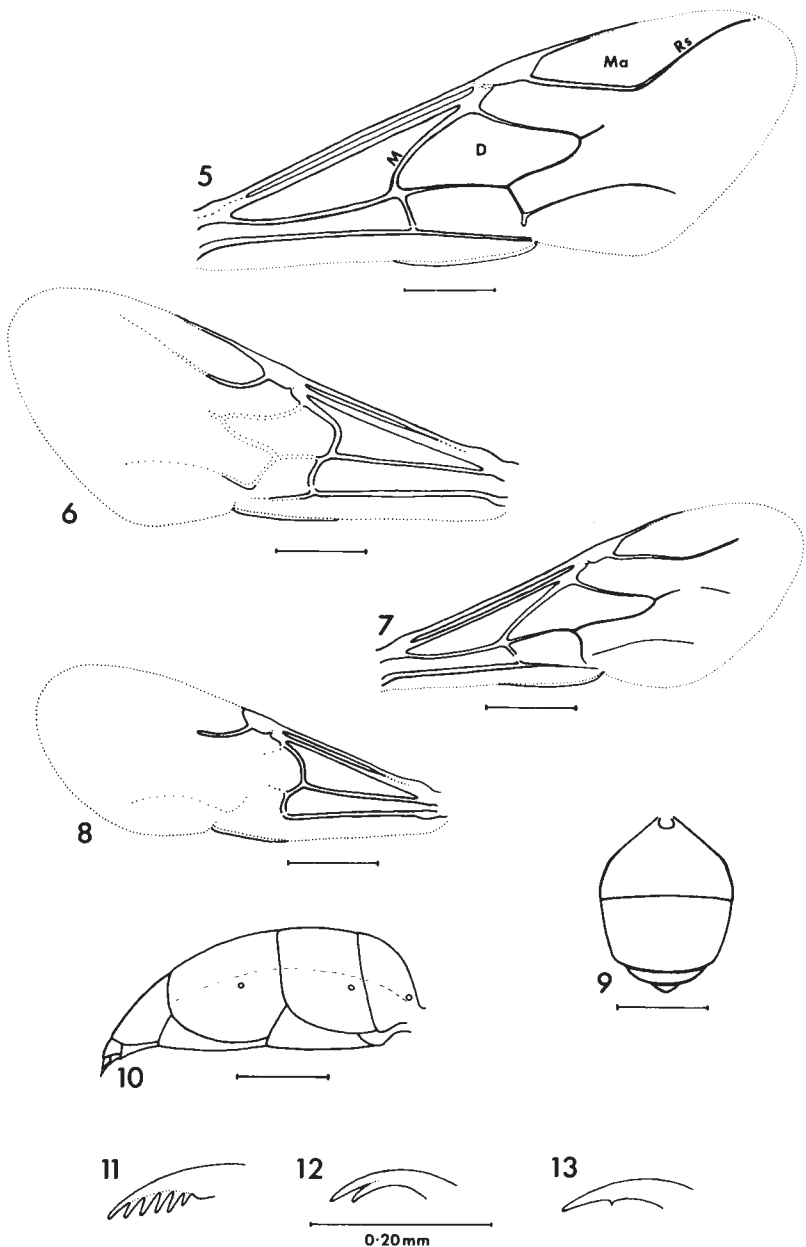

Figs 5-13. 5, *Chrysis ruddii* forewing. Ma, marginal cell. D, discoidal cell. Rs, radial sector vein. M, medial vein. 6, *Holopyga ovata* forewing. 7, *Spinolia neglecta* forewing. 8, *Omalus auratus* forewing. 9, *Amisega* species gaster in dorsal view. 10, *Cleptes* species gaster in lateral view. 11, *Omalus* tarsal claw. 12, *Hedychrum* tarsal claw. 13, *Hedychridium* tarsal claw. Unless indicated otherwise, scale lines represent one millimetre.

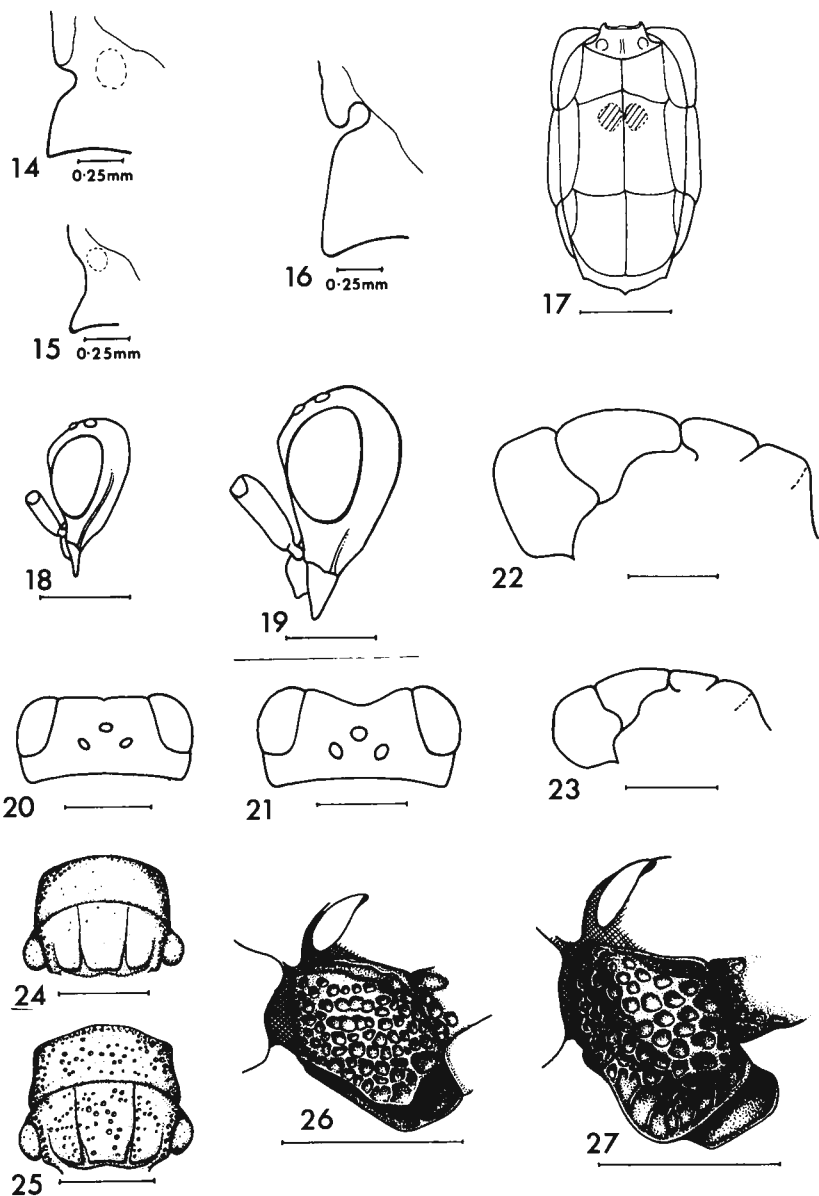

Figs 14-27. 14, *Holopyga ovata* propodeal tooth. 15, *Hedychridium ardens* propodeal tooth. 16, *Chrysis ignita* propodeal tooth and metapleural tooth. 17, *Trichrysis cyanea* gaster in ventral view. 18-19 head in lateral view. 18, *Chrysogona gracillima*. 19, *Chrysura radians*. 20-21 head in dorsal view. 20, *Omalus aeneus*. 21, *Omalus auratus*. 22-23 outline of dorsal surface of thorax. 22, *Chrysura radians*. 23, *Chrysogona gracillima*. 24-25 pronotum and mesoscutum dorsal surface. 24, *Omalus aeneus*. 25, *Omalus puncticollis*. 26, *Omalus aeneus* mesopleuron. 27, *Omalus auratus* mesopleuron. Unless indicated otherwise, scale lines represent one millimetre.

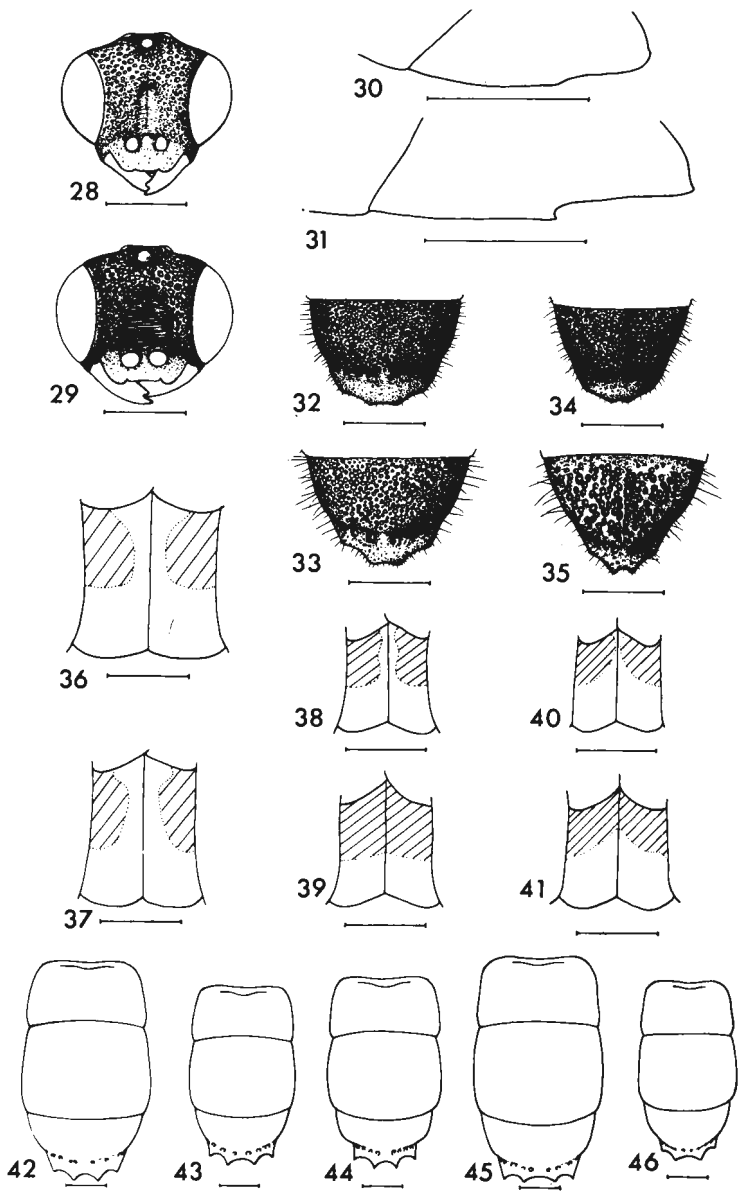

Figs 28-46. 28-29 head in full-face view. 28, *Hedychridium ardens*. 29, *Hedychridium roseum*. 30-31 lateral edge of gastral tergite three. 30, *Hedychrum neimelai*. 31, *Hedychrum rutilans*. 32-35 gastral tergite three in dorsal view. 32, *Chrysis helleni* male. 33, *C. helleni* female. 34, *C. bicolor* male. 35, *C. bicolor* female. 36-41 gastral sternite two with black patches indicated. 36, *C. impressa* female. 37, *C. schencki* female. 38, *C. helleni* male. 39, *C. helleni* male. 40, *C. bicolor* male. 41, *C. schencki* female. 42-46 gasters in dorsal view. 42, *C. bicolor* female. 43, *C. rutiliventris* female. 44, *C. ignita* female. 45, *C. impressa* female. 46, *C. schencki* female. Scale lines represent one millimetre.

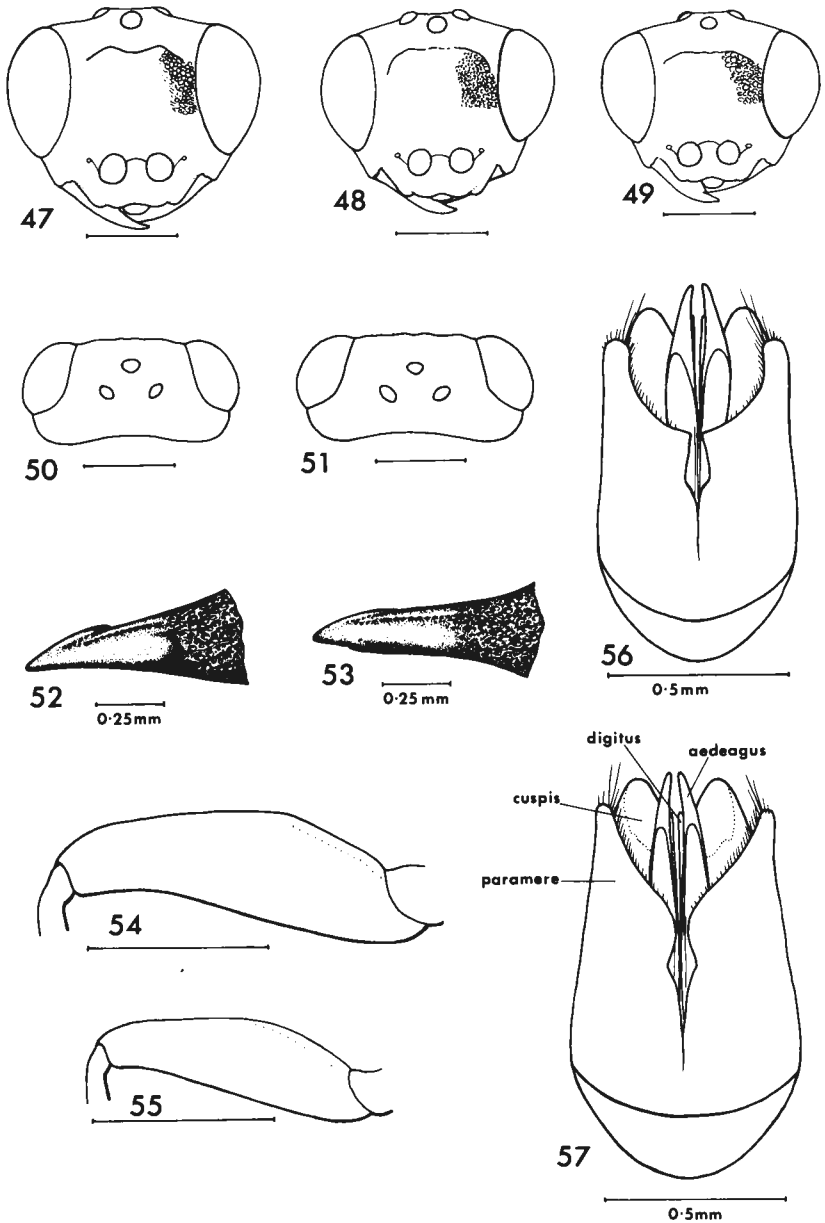

Figs 47-57. 47-49 head in full-face view. 47, *Chrysis impressa* female. 48, *C. rutiliventris* female. 49, *C. mediata* female. 50-51 head in dorsal view. 50, *C. mediata* female. 51, *C. rutiliventris* female. 52-53 mandible viewed laterally. 52, *C. schencki* male. 53, *C. impressa* male. 54-55 femur viewed laterally. 54, *C. impressa* female. 55, *C. schencki* female. 56-57 male genitalia. 56, *C. mediata*. 57, *C. rutiliventris*. Unless indicated otherwise, scale lines represent one millimetre.

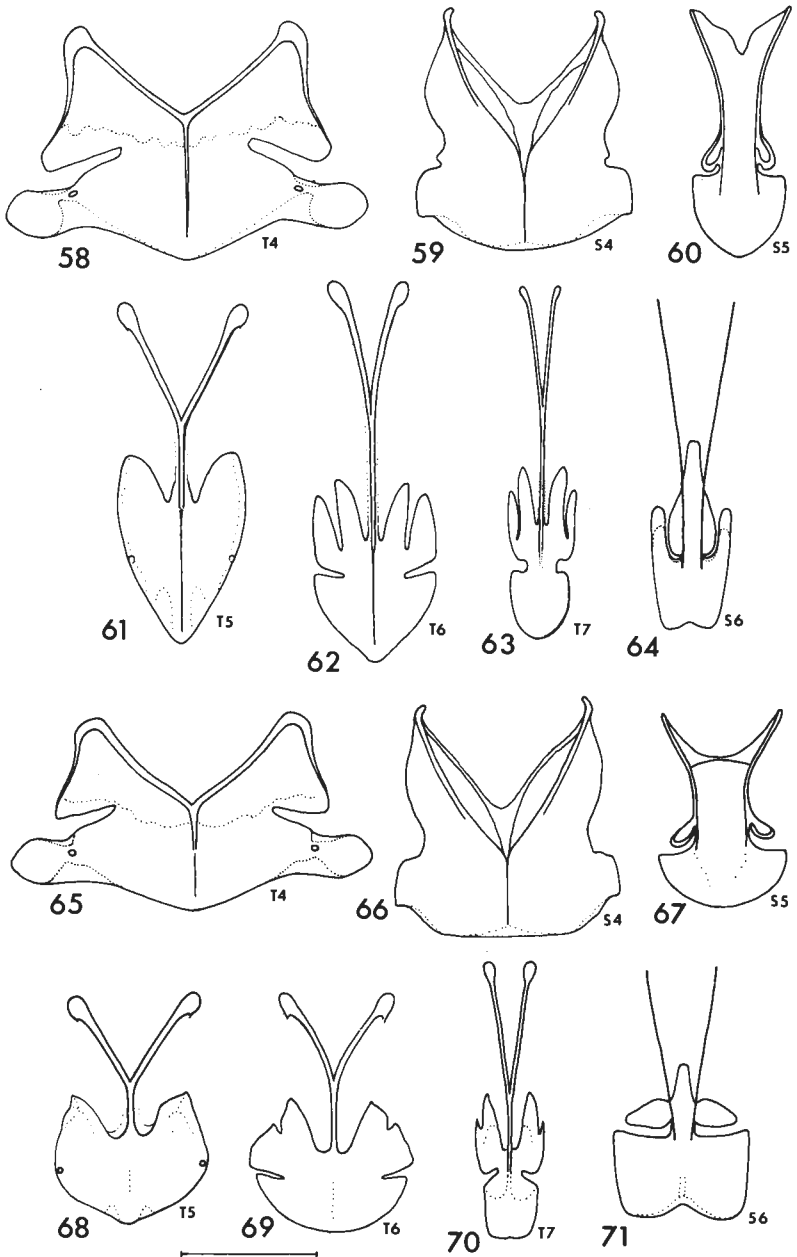

Figs 58-71. 58-64, concealed gastral segments of *Chrysis rutiliventris* female. 65-71, concealed gastral segments of *C. mediata* female. T, gastral tergites. S, gastral sternites. Scale line represents one millimetre.

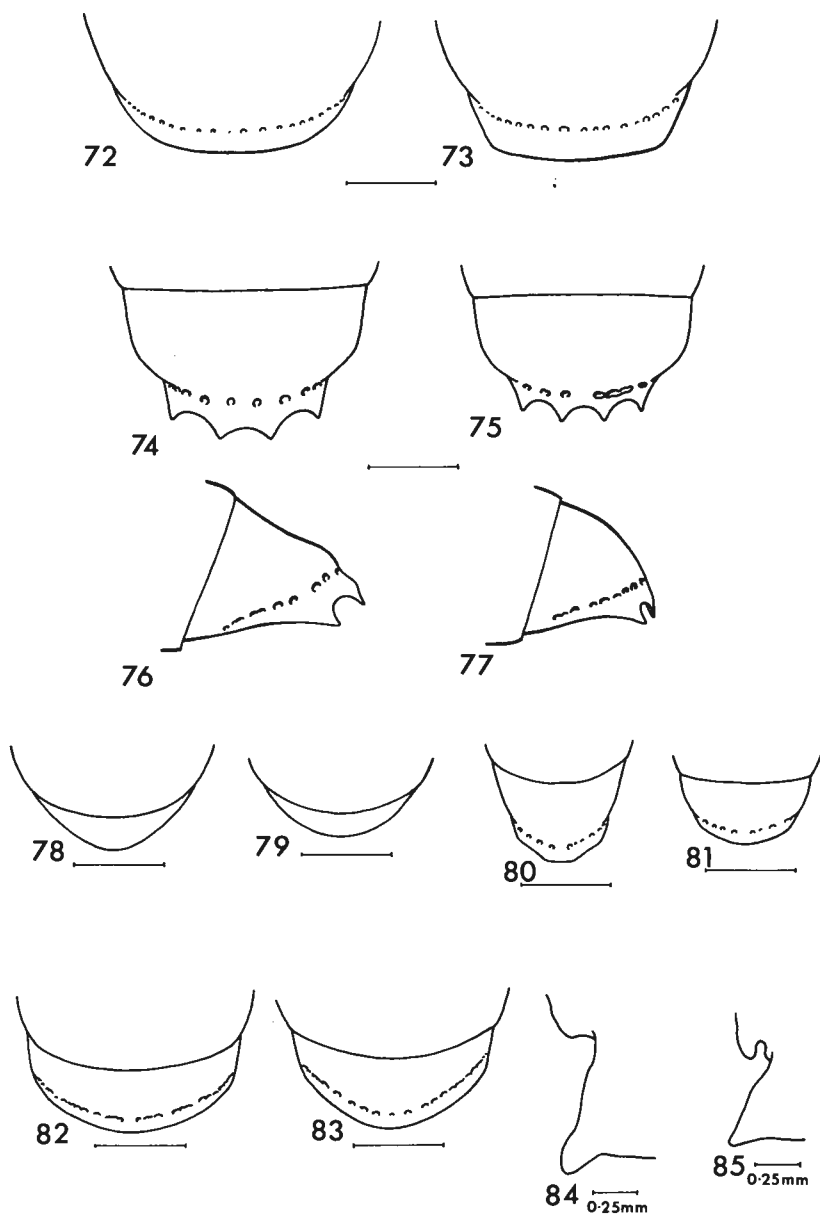

Figs 72-85. 72-73 posterior margin of gastral tergite three of *Chrysura radians*. 72, male. 73, female. 74-83 gastral tergite three. 74, *Chrysis ignita* female dorsal view. 75, *C. ignita* male dorsal view. 76, *C. ignita* female lateral view. 77, *C. ignita* male lateral view. 78, *Hedychridium ardens* female dorsal view. 79, *H. ardens* male dorsal view. 80, *Chrysogona gracillima* female dorsal view. 81, *C. gracillima* male dorsal view. 82, *Spinolia neglecta* male dorsal view. 83, *S. neglecta* female dorsal view. 84-85 propodeal teeth. 84, *Chrysura radians*. 85, *C. hirsuta*. Unless indicated otherwise, scale lines represent one millimetre.

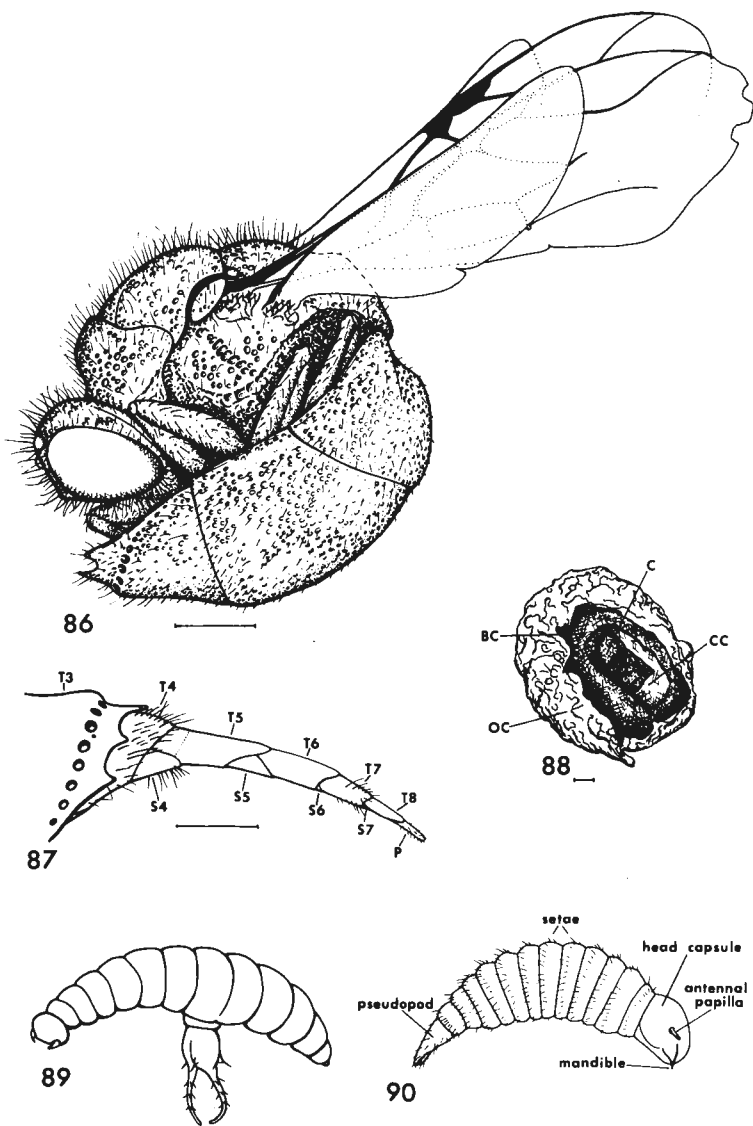

Figs 86-90. 86, *Chrysis ignita* female in defensive position. 87, *C. ignita* female ovipositor formed from modified gastral segments. T, gastral tergites. S, gastral sternites. P, sting palps and 3rd valvulae. 88, cell of *Osmia inermis* containing cocoon of *Chrysurus hirsutus*. C, chrysidid wasp. CC, chrysidid cocoon (thin, light, soft). BC, bee cocoon (thick, dark brown, hard). OC, bee cell outer-case of matted plant material. 89, first instar larva of *Spinolia neglecta* having penetrated the body of its host larva *Osmia villosa* (after Maneval, 1932). 90, *Chrysurus pacifica* (N. America) first instar larva of the planidium type (from photograph, Krombein, 1967). Scale lines represent one millimetre.

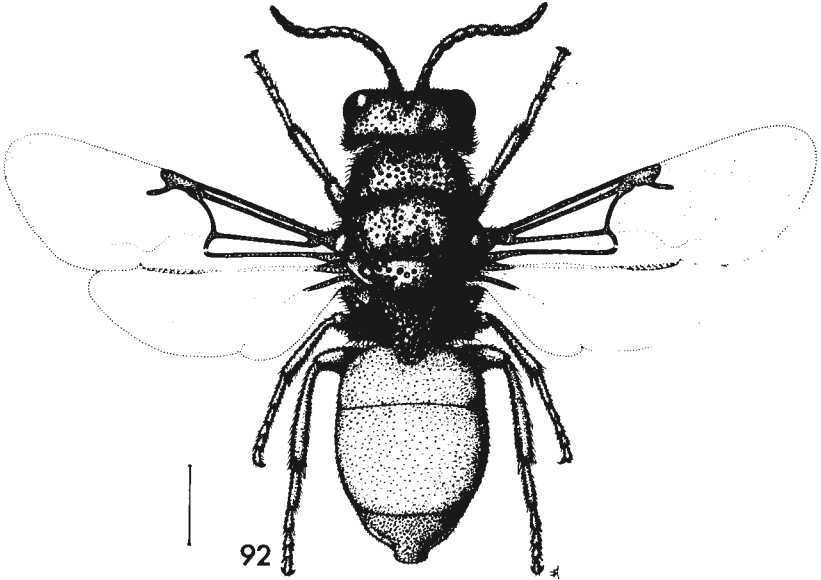
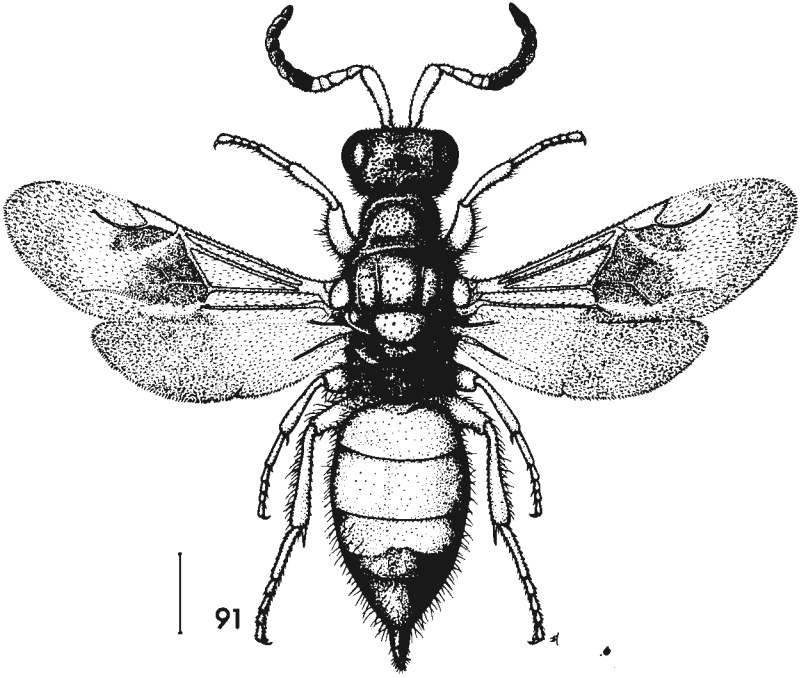

Figs 91-92. 91, *Cleptes semiauratus* female. 92, *Elampus panzeri* female. Scale lines represent one millimetre.

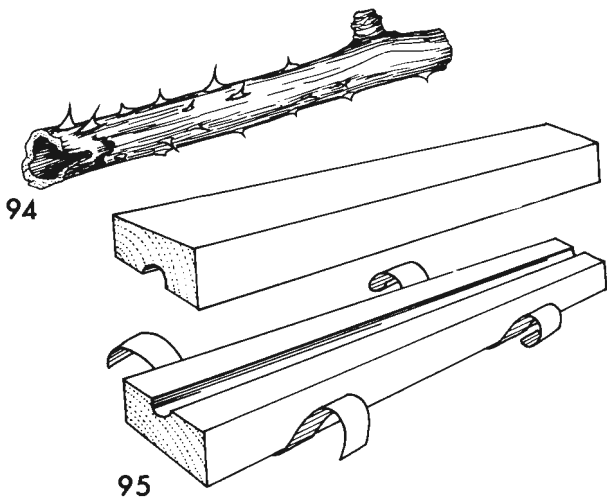
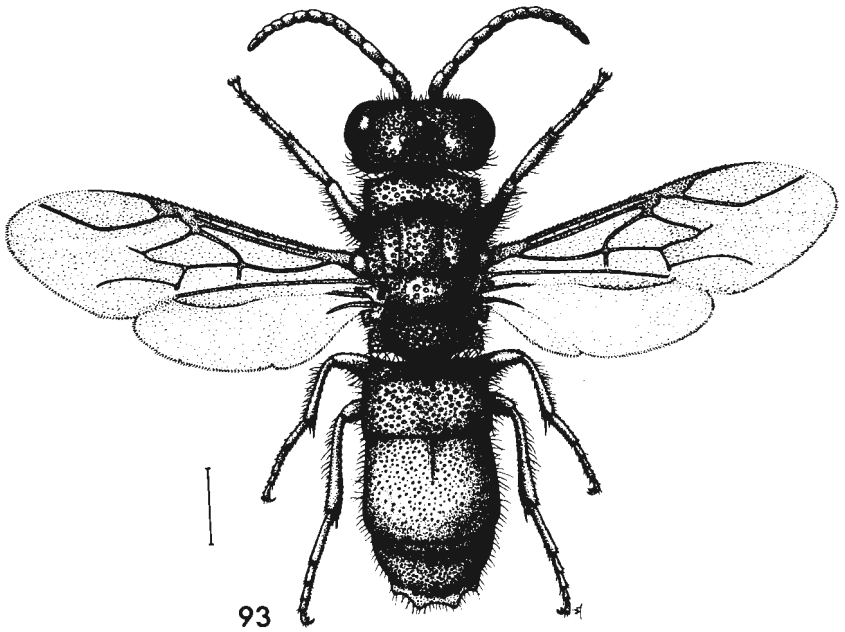

Figs 93-95. 93, *Chrysis angustula* female. 94-95 trap-nests. 94, bramble stem (hollowed). 95, block of wood with hole bored and split. The halves can be held together with tape or rubber bands. Scale line represents one millimetre.

Index

Principal references are in bold. Synonyms are in italics.

- aeneus 16
Allocoeliinae 11
Amiseginae 5, 6, **12**
angustula 6, 9, **21**, 36
ardens 17
auratus 15
aureicolle 8
- bicolor 9, **21**
- Chrysidinae 5, 12, **18**
Chrysis 5, 12, **20**
Chrysogona 13, **20**
Chrysura 13, **19**
Cleptes 12, **13**
Cleptinae 5, 6, 12, **13**
cleptoparasite 6
coriaceum 10, 17
cupreum 8, **17**
cyanea 10, **19**
- Elampinae 5, 12, **14**
Elampus 12, **14**
Euchroeus 18
- fulgida 9, **21**
- gracillima 20
- Hedychridium 12, **16**
Hedychrum 12, **16**
helleni 21
hirsuta 19
Holopyga 12, 17
- ignita 5, 6, **22**, 34
impressa 6, 9, **22**
integrum 8
intermedium 8
- larva 5, 18, **34**
Loboscelidiinae 6, 11
longula 9, **22**
- mediata 5, 6, **23**
- neglecta 9, **18**
niemelai 16
nitidulus 14
- Omalus 4, 12, **15**
ovata 17
ovipositor 5, **34**
oviposition 13, 18
- pallipes 10
panzeri 14, **15**, 35
parasitoid 6
Parnopinae 5, 11
Praestochrysis 20
pseudobrevitarsis 21
Pseudospinolia 18
puncticollis 16
pustulosa 8, 9
- radians 4, 8, **19**
roseum 17
ruddii 21
rutilans 10, **16**
rutiliventris 6, 8, **22**
- sawfly 3, 13
schencki 22
semiauratus 14, 35
Spinolia 13, **18**
sting 5
- trap-nesting 7, **36**
Trichrysis 12, **19**
truncatus 10, **15**
- vanlithi 8
violaceus 15
viridula 21

